



Technical Guide



syncro®

---

The Ultimate Sliding PVC-U Patio Door

# NEW SLIDING PATIO DOORS



## Introducing a new in-line system with even more benefits built in

We're always looking to improve our products. So to keep in pace with customer demand, while staying in step with building regulations, the brand new Syncro system is here. Building on our unrivalled experience, Syncro isn't just our strongest and most secure patio door yet. It also offers better sustainability, design and performance – for you and your customers.



# Market Leading Patio Door

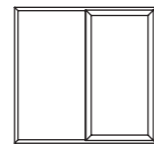

## Close to perfection in the patio door market

The launch of Syncro is another demonstration of how our commitment to research and development keeps our products in sync with the demands of designers, fabricators, installers and homeowners across the board.

But that's just for starters. What makes Syncro really stand out are these brand new features that help it make a really impressive entrance on the marketplace:

- Triple as well as double glazing compatible for even better insulation.
- Better thermal efficiency with U-values as low as 1.3 for double glazed units and 1.0 for triple glazed.
- Maximum width of 3.5m (2 pane)
- Grey substrate for total coordination with modern designs

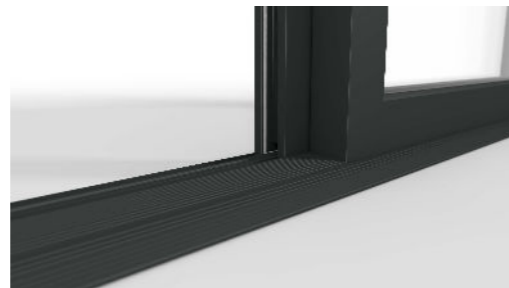

# Security, strength and performance with style



Syncro is available to PAS24 standards, which means you can meet Document Q - the newest security regulations for patio doors. Plus, its improved strength, security and weather performance mean it also satisfies BS6375 as standard.



## Features and benefits



## Finish options



### Colours that match your plans

Syncro is normally manufactured with a white internal finish to maintain a bright, fresh interior, but some colours are available on both sides from stock. Syncro doors are also available with a grey substrate for the look that's so much in demand at the moment.

### Up to 10-year guarantee

Syncro patio door profiles are guaranteed for ten years. Which means you and your customers enjoy all the reassurance of a robust, well-designed, precision-made product that's built to last.

### Profile colours

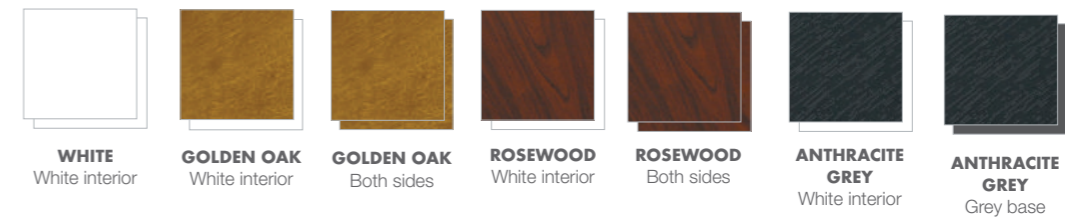

### Handle options and colours



Standard Handles



Slimline with Cup\*



Satin Silver\*, White\*, Black, Gold and Chrome\*

\*Available in selected colours

## MARKET-LEADING PATIO DOOR

U-VALUE .....  
**AS LOW AS 1.0**

WIDTHS OF UP TO  
**3.5 METRES**  
(2 PANE)

PAS24 OPTIONS FOR .....  
**ULTIMATE SECURITY**

DOUBLE OR TRIPLE  
**GLAZING**  
OPTIONS



# Configurations

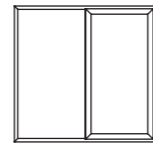

## 2 Pane

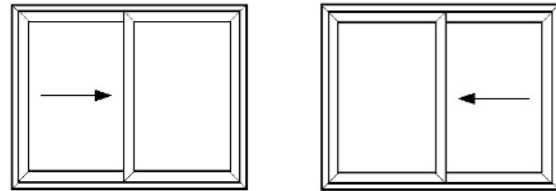

Suitable for openings ranging of up to a maximum 5930mm (four pane) Syncro Sliding Doors are flexible enough to accommodate almost any project.

## 3 Pane Centre Sliding

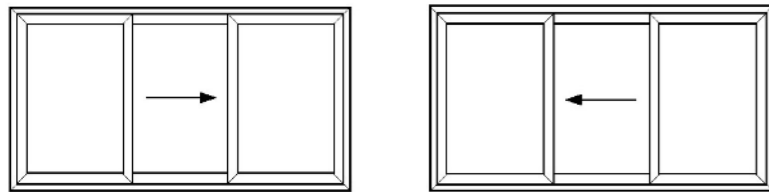

## 4 Pane

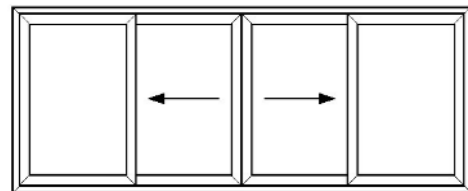

### Full Frame Doors

		WIDTH	HEIGHT
2 PANE	MAX	3500mm* *3201mm - 3500mm maximum height 2100mm	2455mm*
	MIN	1650mm	1950mm*
3 PANE	MAX	5000mm* *4701mm - 5000mm maximum height 2100mm	2455mm*
	MIN	2480mm	1950mm
4 PANE	MAX	5930mm	2455mm
	MIN	3220mm	1950mm

### Doors with Low Threshold

		WIDTH	HEIGHT
2 PANE	MAX	3500mm* *3201mm - 3500mm maximum height 2100mm	2400mm*
	MIN	1650mm	1950mm
3 PANE	MAX	5000mm* *4701mm - 5000mm maximum height 2100mm	2400mm*
	MIN	2480mm	1950mm
4 PANE	MAX	5930mm	2400mm
	MIN	3220mm	1950mm



# Technical information Cross sections

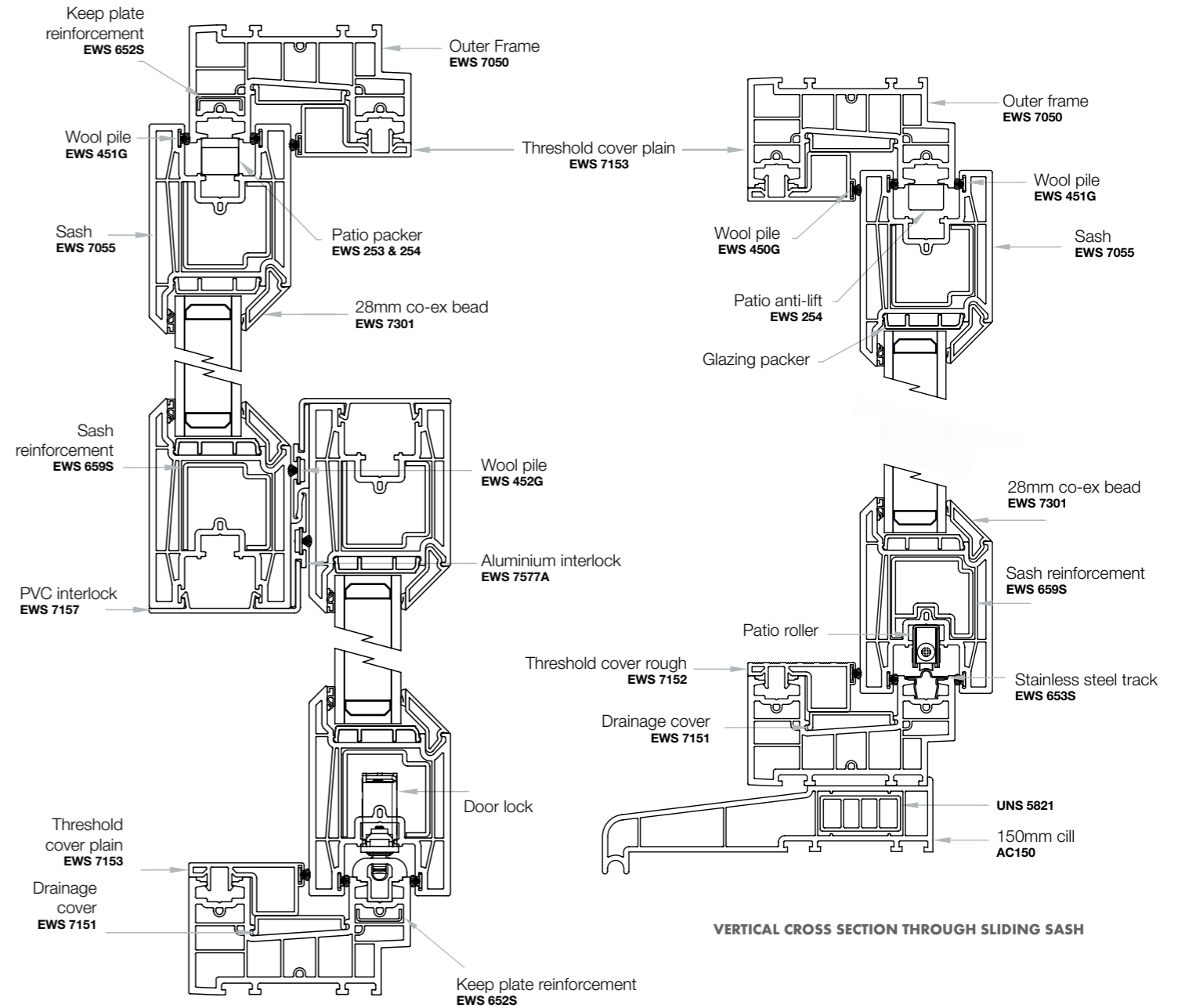
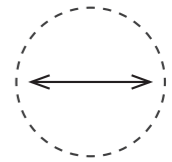

HORIZONTAL CROSS SECTION FOR 2 PANE STYLE

VERTICAL CROSS SECTION THROUGH SLIDING SASH

# Technical information

## Cross sections

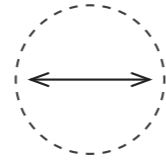

# Technical information

## Low threshold

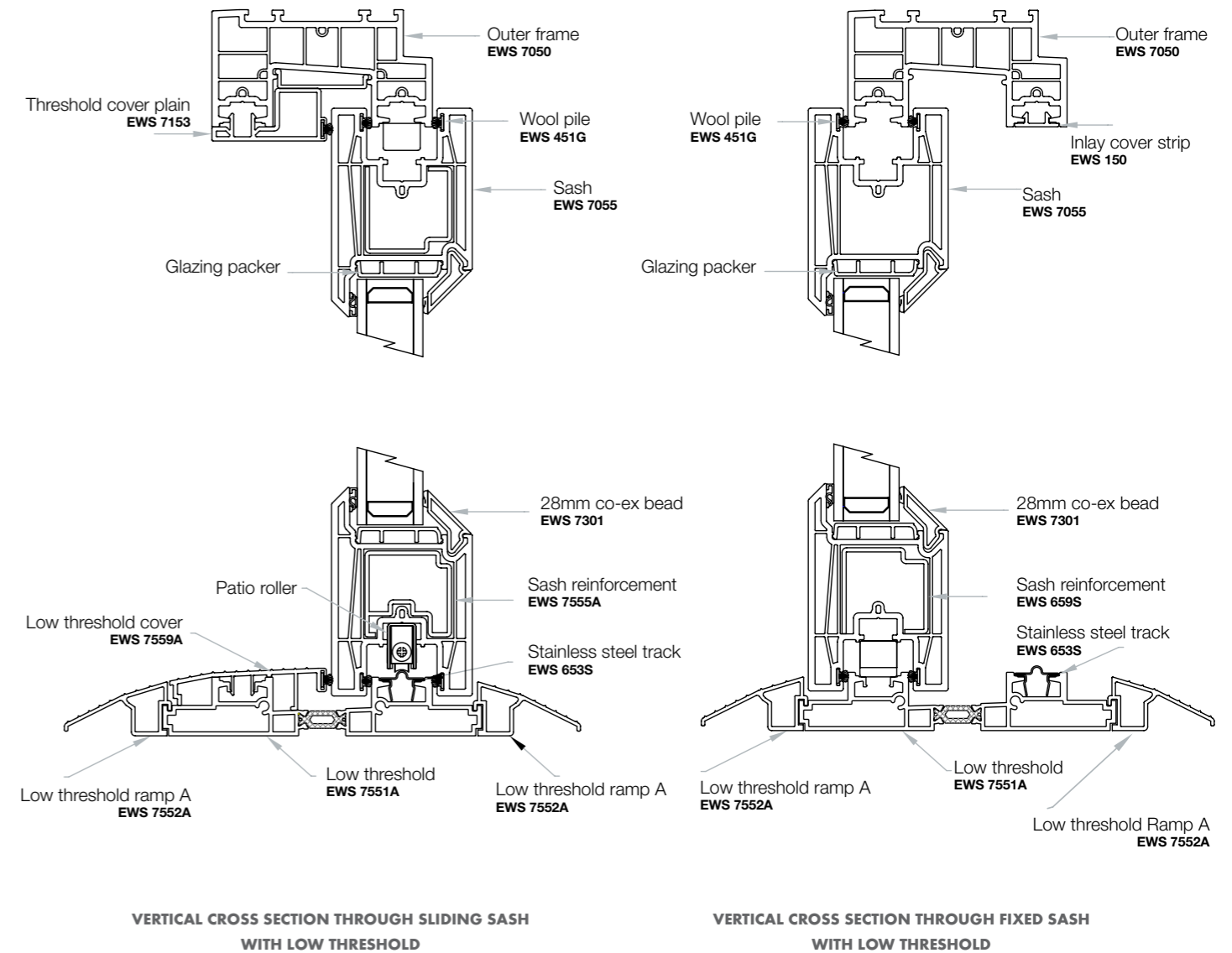
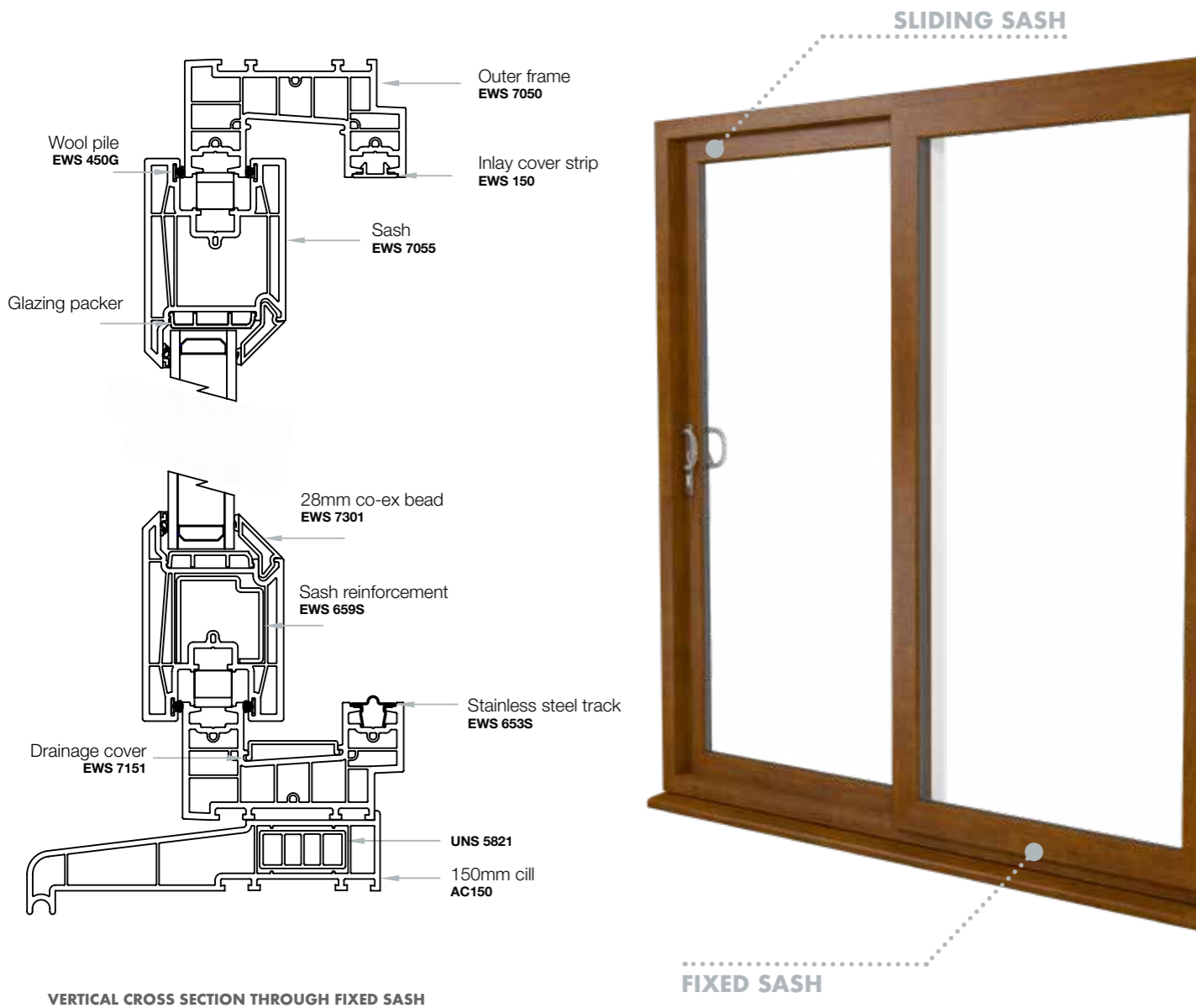
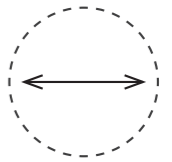



# Technical information Components

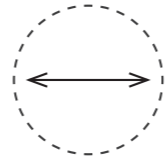

# The Ultimate Eurocell Sliding Door



- Available in 2, 3, or 4 pane configuration
- 28mm double & 36mm triple glazing options
- U-values as low as 1.1Wm<sup>2</sup>/K triple glazed & 1.3Wm<sup>2</sup>/K double glazed
- PAS24 and Part Q approved options
- Thermally broken low threshold option
- New end stop for improved aesthetics
- Additional webs & pips for improved hardware screw retention
- Optional slimline handle with cup
- 2 pane Max width: 3500mm Max height: 2455mm
- 3 pane Max width: 5000mm Max height: 2455mm
- 4 pane Max width: 5930 Max height: 2455mm
- 10-year guarantee

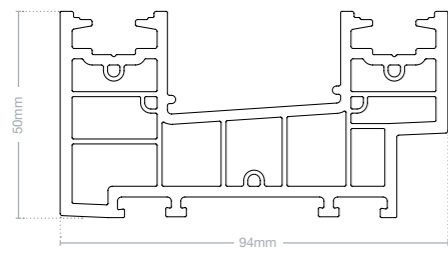

Outer frame  
**EWS 7050**

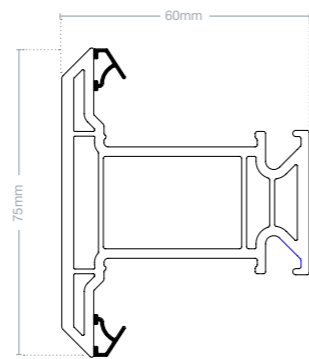

Sash  
**EWS 7055**

Vented Through Frame

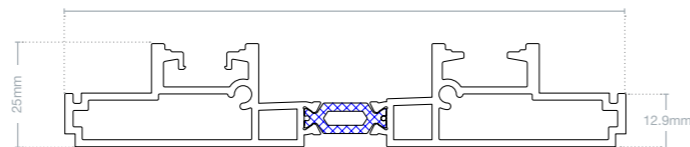
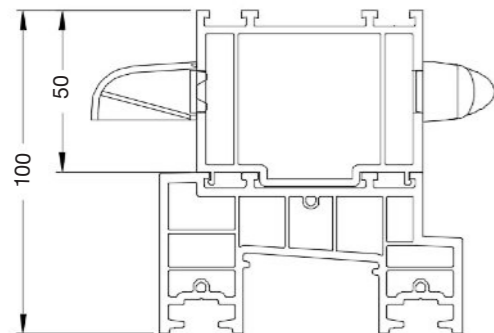

Low threshold  
**EWS 7551A**



Low threshold Ramp A  
**EWS 7552A**

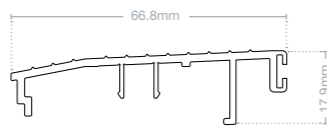

Threshold cover  
**EWS 7559A**

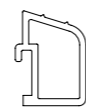

Low threshold ramp B  
**EWS 7558A**  
13.6mm





**High precision manufacture**

We employ the strictest quality management system, going far beyond our BSI approved controls.

