

DEBAR
MAGNETIC DOOR HOLDER

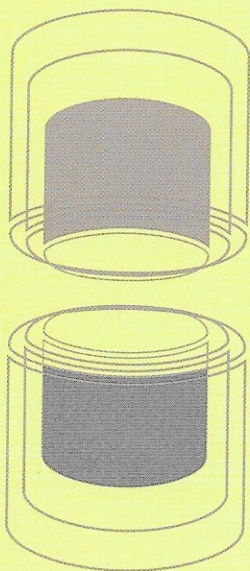

DEBAR protec Magnetic door holder

THE ATTRACTIVE, PRACTICAL SOLUTION TO STABILISING BI-FOLD DOORS

Designed primarily for bi-fold doors, our simple magnetic door holders allow you to hold the swing/pass door to the adjacent panel. This creates a stable set of doors when all panels move and are stacked. Bi-fold doors which include a swing/pass door should always be opened in the sequence shown on page 2. Fitting a magnetic door holder and opening in the correct sequence will avoid the doors becoming out of plumb. Operating the doors differently will cause structural damage to the hinges, rollers, tracks and gaskets/brushes. If the damage is significant then there is a risk to users from a separating door. Structural damage will show as poor sealing, doors not closing correctly due to hinge screws working loose and being compromised. Magnetic door holders also protect users from risk of finger trapping from a loose door whilst in motion.

Whilst the Protec magnetic door holder has been designed to offer an important technical solution we realise that the presence of any door holder is not ideal for the end users from an aesthetic point of view. To minimise the visual impact we have designed the smallest size possible whilst maintaining adequate hold and necessary engineering detail. The range of standard finishes and an option for unfinished for self colour will blend in with the door colour, whilst the positioning at the top of the door is discreet and is not a hazard to users when not engaged.

Main Features

- 30mm (1.18") diameter
- Stock finishes: White Gloss, Black Matt, Grey Matt, Brushed Satin Chrome, Polished Chrome, Gold Polished Chrome & Raw/Unfinished
- 61mm door holder has fixing plates set at 2 degree angles. The width of the door panel and depth of the lever handle will determine where the optimum position is to fix the holder. Full instructions are included with each item along with a fixing pack.
- A resilient polyurethane translucent pad cushions impact whilst also protecting surfaces from contact damage
- Two options on height; 61mm for Lever/Lever handles, 26mm for flat handles or doors without a handle
- Central fixing point with an additional anti-rotation grub screw
- Backplate design allows for rivet nut fixing if required, Ideal for chamber systems
- Engineered from die cast Zinc

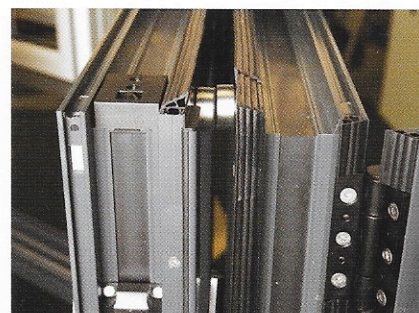
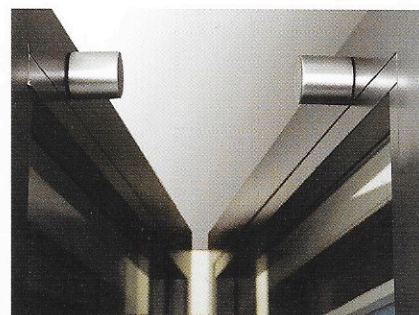

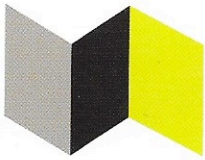

DEBAR

MAGNETIC DOOR HOLDER

Correct door opening sequence

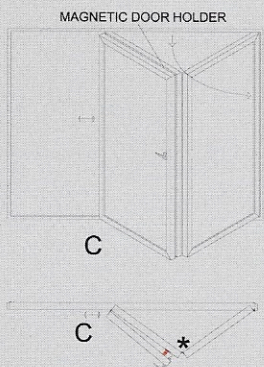
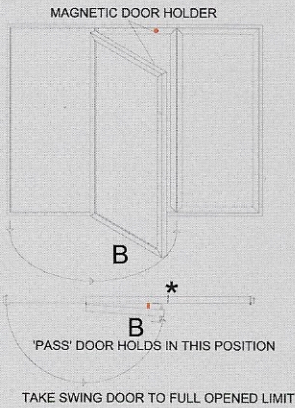
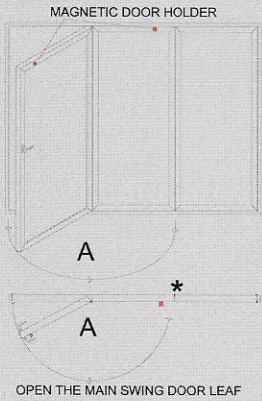

*
RELEASE THE GEARBOX BOLTS FROM INSIDE
AND SLIDE THE COMBINED DOORS TO THE SIDE

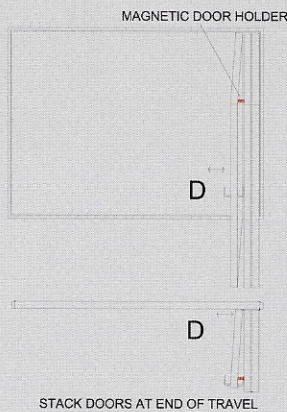

Door holder dimensions

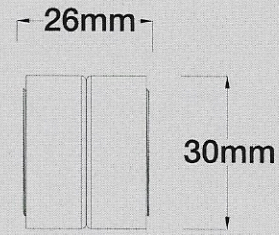

The Debar magnetic door holder is available in 2 sizes, a 61mm version and a 26mm version.

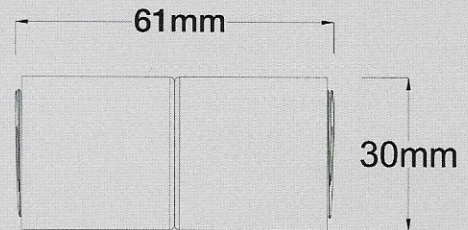

Fitting options included in the pack

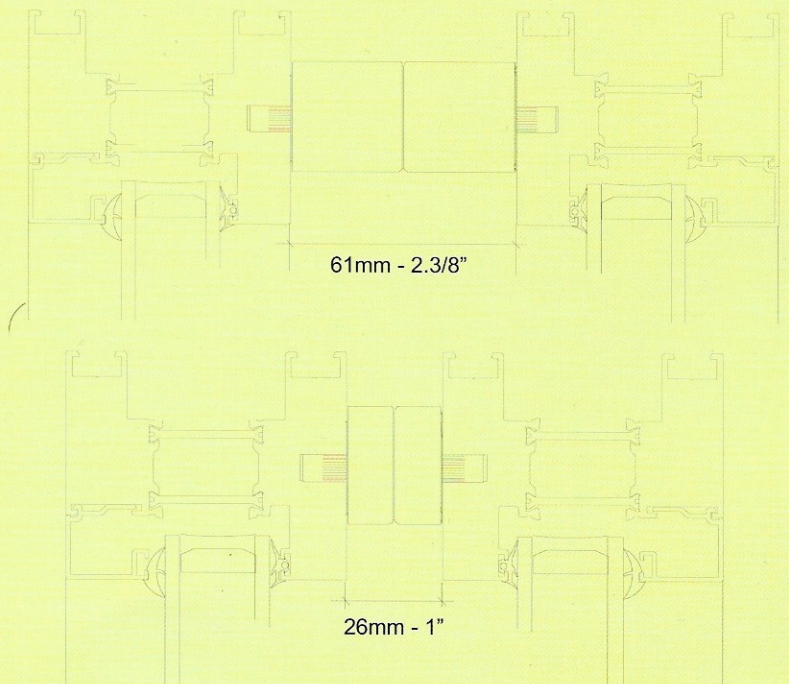
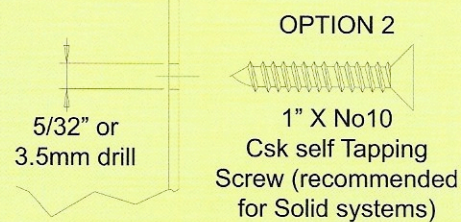
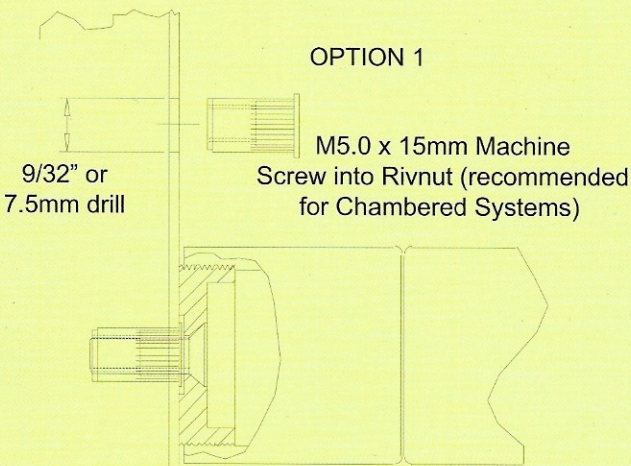

Wh
Bra

Concept House, Brackenbeck Road
Bradford, BD7 2LW. UK

TEL: +44(0) 127 467 3547
FAX: +44(0) 127 434 1122

Email: sales@bifold-hardware.com
www.bifold-hardware.com