

**The Ultimate**  
**Composite Door Collection**

**Installation Guide**

**INDEX**

<b>SITE SURVEY</b>	
• OPENING INSPECTION	<b>3</b>
<b>PRE-INSTALLATION</b>	
• TOOLS REQUIRED	<b>4</b>
<b>INSTALLATION</b>	
• SIDE, TOP & FAN LIGHTS	<b>5</b>
• FITTING A CILL	<b>6</b>
• FRAME INSTALLATION	<b>7</b>
• FINAL FIXINGS	<b>8</b>
• PACKERS	<b>8</b>
• A LEVEL LINE	<b>10</b>
<b>MINOR TWEAKS</b>	
• KEEP ADJUSTMENT	<b>13</b>
• HINGE ADJUSTMENT	<b>14 - 15</b>
<b>FINISHING TOUCH</b>	<b>16</b>
<b>FINAL INSPECTION</b>	<b>17 - 18</b>
<b>HOMEOWNERS INSTRUCTIONS</b>	<b>19 - 20</b>

**SITE SURVEY**

***Opening inspection***

- The aperture for the new door must be flat, level, straight, plumb and square at every single side. There should be a solid structure to fix the frame.
- The aperture load bearings must not be transferred to any part of the frame when fitted.
- Prepare the aperture by making sure it is clean.
- Remove any old silicone and brush down the threshold.
- Check the aperture's height, width and diagonals to ensure the opening is equal on all sides and square.
- Generally three measurements should be taken.

**NOTE:** The smallest measurement of width and height used to determine manufacturing sizes.

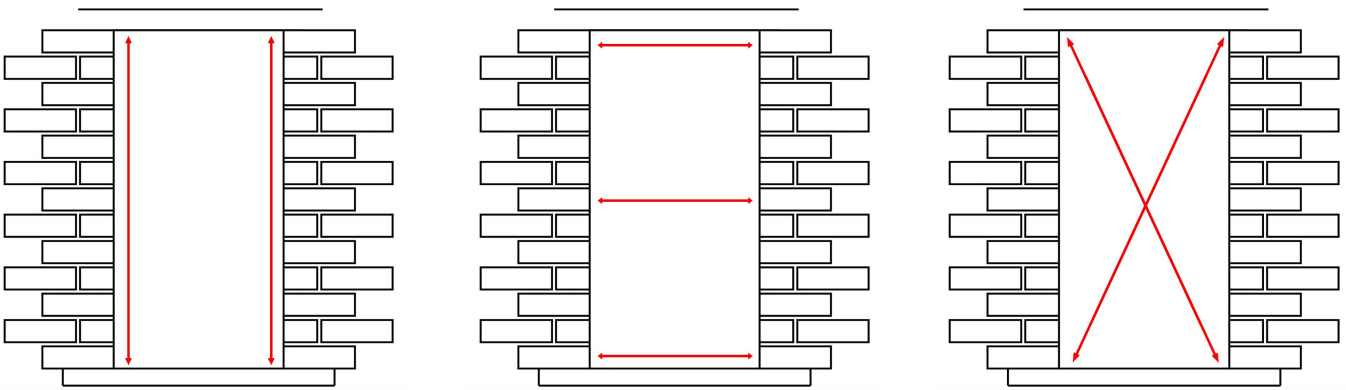

- Use a tape measure to verify the aperture overall height and width. At least three measurements must be taken.
- Smallest height and width measurement will determine the overall frame manufacturing size.
- By measuring the diagonals verify the aperture is square.

**NOTE:** Must allow minimum 10mm tolerance between your opening size and the frame sizes for manufacturing

**PRE-INSTALLATION**

**Tools required**

This composite door is supplied in as complete and "ready to fit" condition as possible. Depending on the installation however, some parts may require a small amount of additional work on site.

The following tools are therefore all considered essential.

Impact driver or hand drill, bits and fixings to suit, spirit level and tape measure. Plastic hammer. Long No. 8 pozi screwdriver. Sharp chisel or moon knife. Hacksaw or table saw. 2mm, 4mm and 5mm Allen keys.



Prior to commencing any installation work, the sizes, type and condition of all doorsets should be checked against both the survey sizes as well as the actual aperture sizes.

The doorset specification, including hardware, glazing and door style, should be checked against the order acknowledgement provided. Before discarding any packaging for ancillary components which may be loose, check that all ancillary components required are accounted for. If the order has arrived incorrect or damaged, this must be reported before installation. Fitting the door without providing notification of the issues, may void a warranty claim.

**NOTE:** Composite doorsets must be stored in a dry location prior to installation. Prolonged exposure to moisture may invalidate the product guarantee.

Cylinder keys will be found screwed to the outer frame.

After removing existing products, re-check diagonals and aperture size before positioning the door. Check the cavity to see if timber blocks need to be wedged in place for proper fixing.



## INSTALLATION

The importance of installing the doorset outerframe plumb and square within the aperture, without twist, racking or distortion of any member, cannot be overemphasised. Repeatedly check the squareness and alignment of the outerframe during the process of installation.

The positioning of the new frame in the aperture is fundamental to the success of the installation. In general the replacement doorset shall:

- Bridge to cavity
- Cover the damp proof course
- Be set back as far as possible in the aperture to minimise exposure to the elements

### *Side, top and fan lights*

When side, top or fan lights have been ordered without welding, couplers will be supplied. The couplers will require cutting to your required size.



Measure, cut and fix the coupler to the light.



Make sure the couplers are positioned the correct side to connect with the door frame and the drainage holes are positioned at the bottom and at the external face of the light.



Insert fixing holes to the coupler every 600 millimetres.



Place the door fixings to the door frame from the light glazing channel. This way no screw heads will be on show when the door is open.

## INSTALLATION

### *Fitting a cill*

- The need for any cill should be determined at the beginning of the project.
- The size of the cill should be as such that there is an overhang of at least 25mm from the face of the building.
- The installer should determine how the cill should be fitted, taking into account features such as horns. An additional 100mm length of cill is provided to allow for cill horns. For this, the end caps will require cutting to the correct length.



Measure and cut the cill to the required size, taking into account for cill horns if desired.



Attached the cill end caps using adhesive to seal and fix in place.



Place the cill on to the aperture. Use a spirit level to assess the level of the cill. If required, place packers under the cill, check the level and adjust if necessary.



Ensuring the hinge side is slightly higher than the closing side, will give you a head start when toe and heeling the door.

**INSTALLATION**



Run a bead of silicone along the surface and position the cill in place. No screws should be put into the threshold or cill.



Now run a bead of silicone along the cill back line and position the frame into place.

**Frame installation**

Fixing methods will be influenced by:

- The presence or absence of a wall cavity
- The nature of any cavity
- The relative positions of the frame and cavity
- The position of the plaster line and the need to preserve the interior decorations
- The design of the reveal



Pack the frame at the top opening corner and the bottom hinge side.



'Toe and heel' the frame, just as you would if installing a glass pane.

INSTALLATION

**Final fixings**

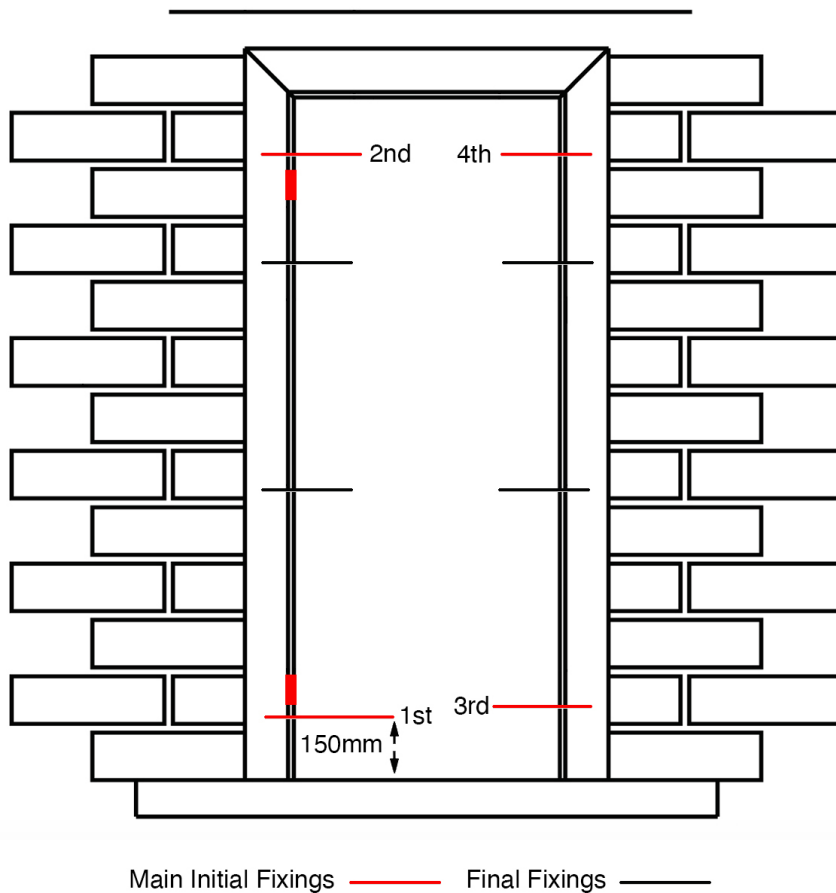

**Fixing distances**

Both side of the frame shall be secured using the following guidelines to determine the fixing spacings:

**NOTE:** If it is impossible to find a suitable fixing position, then the nearest possible fixing should be used.

- Corner fixings should be a minimum of 150mm and a maximum of 250mm in from the external corner.
- No mullion or transom fixings should be closer than 150mm, or further than 250mm from the centre line of a mullion or transom.
- Intermediate fixings should be at centres no greater than 600mm.
- There must be a minimum of 3 fixings on each door section jamb - The figure above illustrates the ideal fixing positions to counter balance the door weight.

**Packers**

Appropriately sized installation packers shall be used adjacent to fixing positions to prevent outer frame distortion during installation. Installation packers should be incompressible, resistant to rot or corrosion, and span the full width of the outer frame profile. The fixings should be tightened so that the frame is held securely against the packers. Take care not to over-tighten the screws and distort the frame. Apply a small amount of silicone mastic to the shanks and heads of fixings that pass through the outer frame to ensure that no water penetrates into the frame.

**NOTE:** Packers shall be used adjacent to hinge/locking points.



INSTALLATION

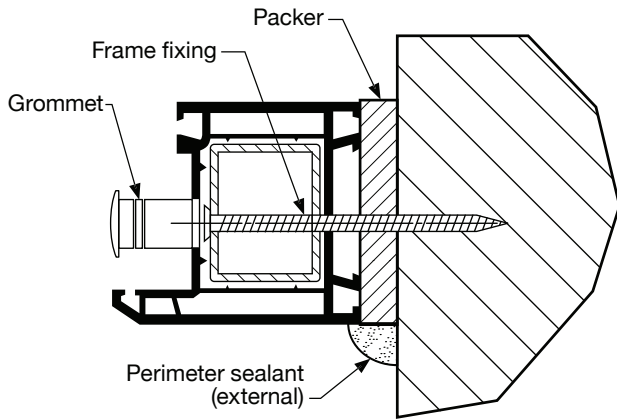

As a general rule, 7.5mm Direct Frame Anchors are recommended for fixing of plastic outerframe composite doorsets.

The head of any through-frame fixing must be seated beneath the outer wall of the plastic outerframe member within the hollow chamber to prevent distortion or cracking of the frame.



Push the bottom hinge side corner into place back on the cill, fix the bottom rail and plumb the door to suit from this fixing.



The fixing would ideally be 150mm from the bottom, however you may have to bring slightly lower to accommodate the hinge or pick up on a decent brick to fix against.



Check the frame is plumb. If not plumb, the door will either swing open or close on its own to the angle it is set too.



Fix the top hinge corner into position.

**INSTALLATION**

The door must be fitted square and plumb. When placing fixings to the hinge side frame, ensure the frame is sat true and level.



It is not always necessary to level the lock side because the sash will show if it is in the right place. Check your running line and if it is out of twist, it will show on the slab. If the door is out, simply push or maneuver the bottom of the door back onto the cill and the top end to suit.

Fix the opening side bottom corner. Make sure the margin at the top and bottom are the same. Then fix the top corner of the lock side.

**NOTE:** Remove the packers placed between the door slab and frame before setting the door.



**A level line**



If the line is not level (as demonstrated above) and is too high on the keep side, the easiest way to alter is to adjust the frame. Loosen all keep side fixings and use packer/s to lift the frame. 'Toe and heel' the frame, just as you would if installing a glass pane. It is good practice to allow the running line to be slightly higher at the keep end. As the door is used, it likely the door will flex and may slightly drop as the door settles.

**INSTALLATION**



Main adjustments should always be made to the frame.



Continuously check the door is set square and plumb. Check handle and locking mechanism operation.



Once happy with the running line and door operation, place fixings within the frame head.



Fixings through the door threshold is not advised and a bead of silicone is recommended.

INSTALLATION



If sidelights require a bottom fix, ensure that adhesive is placed on the drilled hole and the inserting screw, to completely seal the fixing.



Aro-Seal 1101 adhesive is the preferred choice.



Fix both sides of the frame in the middle. The use of packer/s can assist the frame to not bow out.

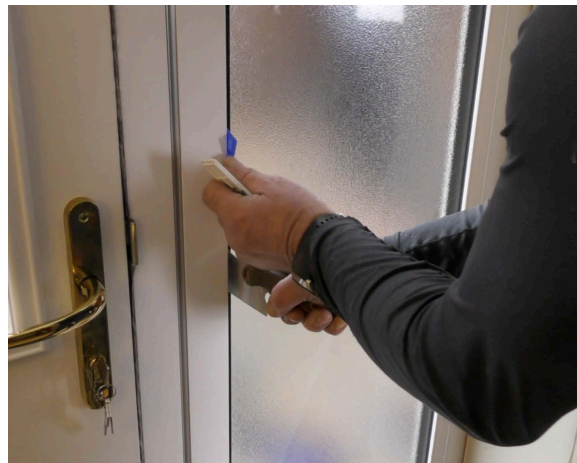

It is likely you will find a natural bow on the keep, which will require correcting by packing out.



Use packers when glazing to ensure the glass pane is secure.



Tap beading into place using a plastic hammer.

**MINOR TWEAKS**

***Keep adjustment***

If the latch is catching or not sitting flush into the keep, you can adjust the keep. Remove the screws, adjust to suit and fix in the altered position.



**MINOR TWEAKS**

**Hinge adjustment**

The hinges are adjustable both vertically and horizontally.

(Remove top and bottom covers '1 & 2' to conduct vertical adjustment)

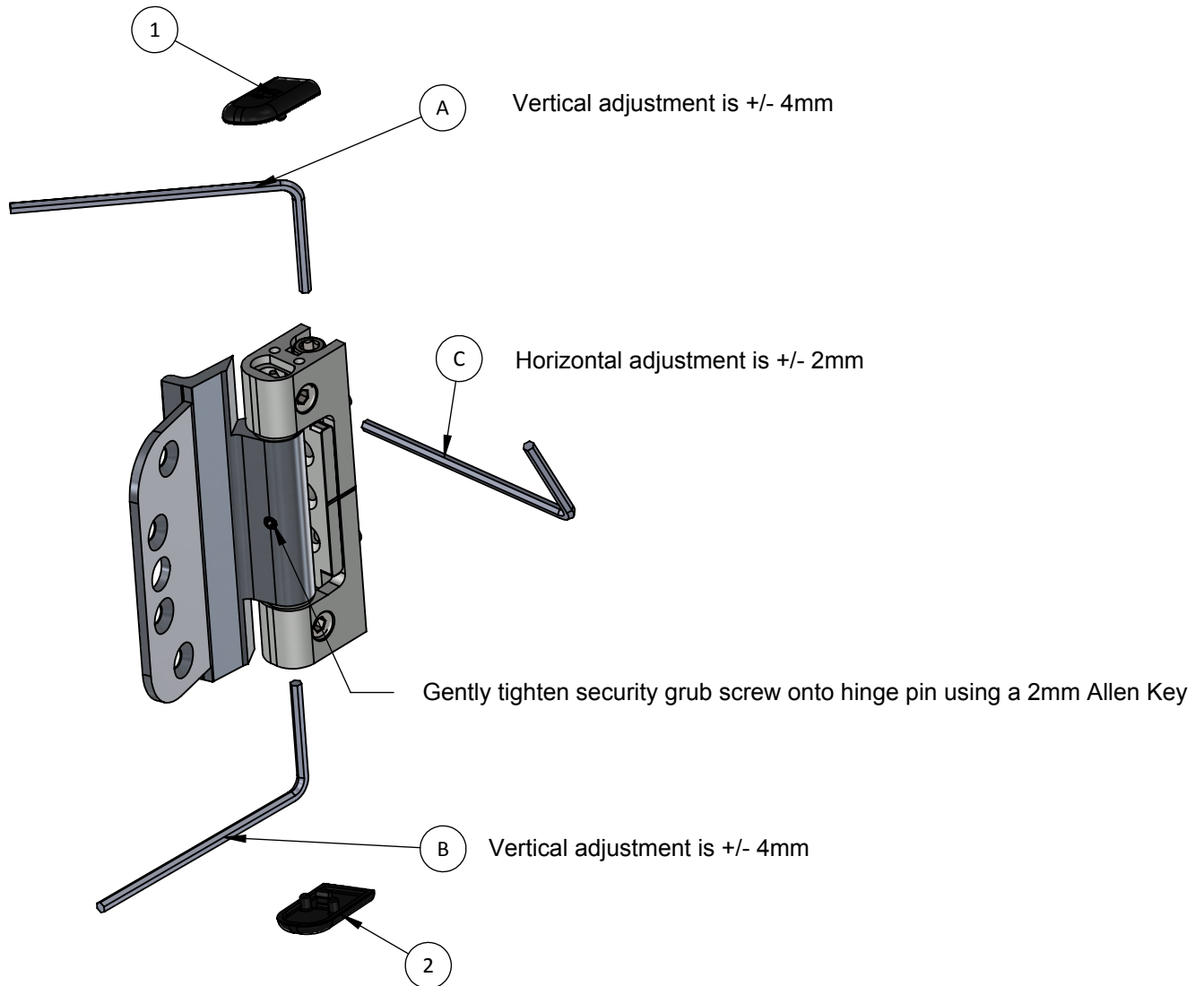

- To adjust vertically upwards.  
Firstly slacken the bottom most adjustment screw using a 5mm Allen Key 'B' the desired distance. Secondly tighten the top most adjustment screw until tight.
- To adjust vertically downwards.  
Firstly slacken the top most adjustment screw using a 5mm Allen Key 'A' the desired distance. Secondly tighten the the bottom most adjustment screw using a 5mm Allen Key 'B' until tight.
- To adjust horizontally.  
Rotate the two side adjustment screws anti-clockwise or clockwise using a 4mm Allen Key 'C' until the desired distance is achieved.

**MINOR TWEAKS**

***Hinge adjustment***

The hinges can be fine-tuned. If needed, use an allen key to turn clockwise and send the door towards the hinge and anti-clockwise to send towards the latch. Make sure you provide equal number of turns to both bolts.

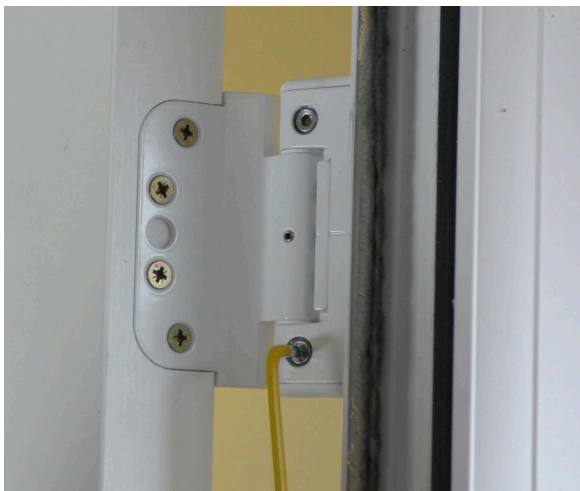

If you wish to move the door slightly up or down, remove the hinge cover plates and use an allen key to adjust. By loosening the top bolt anti-clockwise and tightening the bottom bolt clockwise, this will move the hinge upwards. Use the level line as guidance.

To lower the door, follow the same method but turning in the opposite direction. Make sure you provide equal number of turns to both bolts and on all hinges.

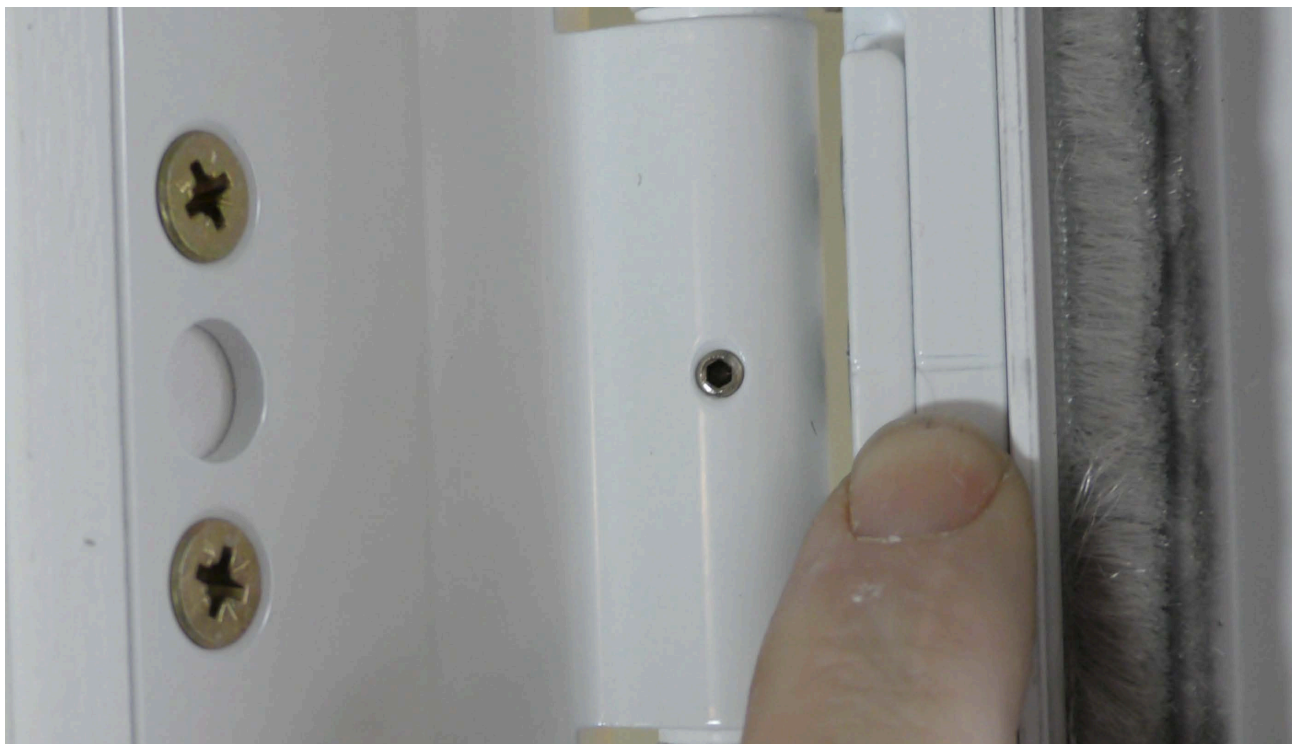

The level line will display the adjustments made. Make sure the same amount and adjustment direction is made to all the door hinges.

**FINISHING TOUCH**



**NOTE:** When sealing perimeter joints take care to ensure any drainage channels are not blocked or obstructed.



Efforts must be made during installation to ensure that debris such as wet plaster does not foul drainage paths nor impair operation of hardware. Neither sand and cement, nor plaster should be used to fill the gap between the frame and the structural opening.

All protective films placed on the outer frame profiles and door facings should be removed as soon as the installation is finished, and prior to perimeter sealing.

The purpose of a perimeter sealant is to prevent water and air leakage between the aperture and the doorset. When sealing perimeter joints take care to ensure any drainage channels are not blocked or obstructed.

Depending on the property and its structural material, additional trims may be suitable to create a frame window. Additional trims are not included.



## FINAL INSPECTION

After installation, a final inspection should be carried out to ensure that the installation is of the highest standard. There should be a formal procedure for checking the installation, which should use a checklist to ensure that all relevant points are checked.

A general checklist is provided on page 18.

It is advisable that these checks are carried out in the presence of the client. It is good practice to ensure that the customer is familiar with the method of operation of the installed doorsets.



Operating features such as key locks, hook-bolts and latches shall be checked and should be demonstrated so that the client and tenant know how to use them. This is especially important in the case of exits that may be used in fires.

**INSTALLATION**

***Final inspection checklist***

Area to be checked	OK? Yes/No
<b>Visual Appearance</b>	
1. Doorsets installed plumb, square and vertical?	
2. Exposed faces free from surface damage?	
3. Doorset clean and all protective film removed?	
4. Check for weld cracks, clean & consistent shadow grooves	
5. Check for damage to surrounding aperture	
6. Check all internal trims installed correctly	
7. Check site clean and all debris removed	
<b>Glazing</b>	
1. Glazing as specified?	
2. No cracks, scratches on glass, or signs of sealed unit failure?	
3. Obscure glasses oriented correctly?	
<b>Doorset Operation</b>	
1. Door leaf opens & closes correctly?	
2. No air gaps between frame seal and door leaf?	
3. No scraping/rubbing between hooks and strikers?	
4. When doors slam, no mullion bounce, nor outer frame movement?	
5. All hardware correctly lubricated?	
6. All hardware attached with correct number of fixings?	
<b>Fixing</b>	
1. Through-frame fixings used at correct distances?	
2. Fixing heads located within frame profile and cover caps filled?	
<b>Sealing</b>	
1. Sealant joints have smooth finish, and are of correct shape?	
2. Sealant to be continuous around frame run?	
3. No excess sealant to be present on frame faces?	
<b>Drainage</b>	
1. Threshold drainage channels free from obstructions?	
2. Sub-sill end caps in place, and attached firmly?	

# HOMEOWNER INSTRUCTIONS FOR COMPOSITE DOOR USAGE

**NOTE:** After installation, a full demonstration should be made by the installer to the homeowner.

## Caring for your new Composite Door

You have chosen a high quality GRP Composite Door that is incredibly durable and easy to maintain.

Regular cleaning will ensure it always looks its best.

Here is how to care for each part of your new door:

### 1. Glass

Clean with glass cleaning liquid or warm soapy water and a soft cloth or sponge. Avoid abrasive pads and solvents.

### 2. Frames and panels

These can be easily cleaned with warm soapy water and a soft cloth or sponge. Do not use abrasive pads or solvents as these may scratch or damage the surface. A special, solvent-based UPVC cleaner may be used to remove stubborn dirt and grease.

### 3. Locks, hinges and hardware

Hardware can be cleaned with mild soapy water and a soft cloth. Avoid abrasive pads, solvents or strong polish as they may scratch or damage the hardware. For a smooth opening, lightly oil or lubricate moving parts once or twice a year.

**NOTE:** Composite doors are structurally sound and will not bow as a result of any water ingress. However, in order to maintain the door and prevent your door from bowing throughout its long life, the hook locks should always be engaged in their keeps when the door is closed. Failure to engage the locks and close the door on the centre latch only can induce a bow over time. Failure to engage the hooks will therefore invalidate the guarantee against bowing.

## Door lock / handle operation

To Lock:

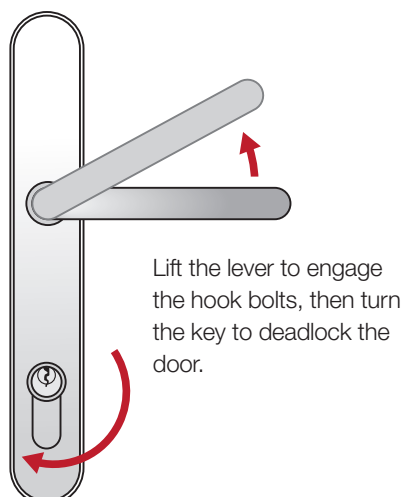

To Unlock

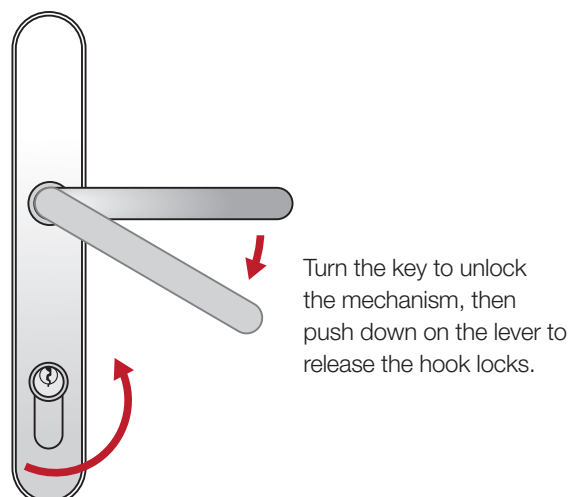

# Locking and unlocking your new door

## **1. Locking the door**

Close the door and lift the lever upward. This action will project the compression bolts and hooks into their respective keeps.

Rotate the key one revolution. The door is now fully weathered and secure.

## **2. Unlocking lever / lever handle door**

Insert the key in the cylinder and rotate one revolution. Next, push the lever down to fully retract the compression hooks and bolts, the latch will automatically retract when the lever is depressed.

The procedure is the same for internal and external operation.

## **3. Unlocking lever / lever off –set handle door**

To unlock the door from inside when a lever / lever offset handle is fitted; simply follow the procedure as in point 2 above.

To unlock the door from outside, insert the key and rotate, this will unlock the gearing. Depress the lever, which will withdraw the compression bolts and hooks, the latch will not operate at this point.

To gain access, simply turn the key again in the same direction as to unlock the gearing, the latch will remain withdrawn whilst you hold the key in the rotated position.

## **Optimum security**

Optimum security can only be achieved when both compression bolts and hooks are engaged in their respective keeps and the gearing is deadlocked with the key. Closing the door when using the lever / offset lever handle will provide an instant security benefit but this does not constitute high security locking of the system.

To ensure the total benefits of the locking system are employed, follow the operation instructions set out above.